

ZEFIRO

Dual discharge air cooler

AIR HEAT EXCHANGER MANUFACTURER

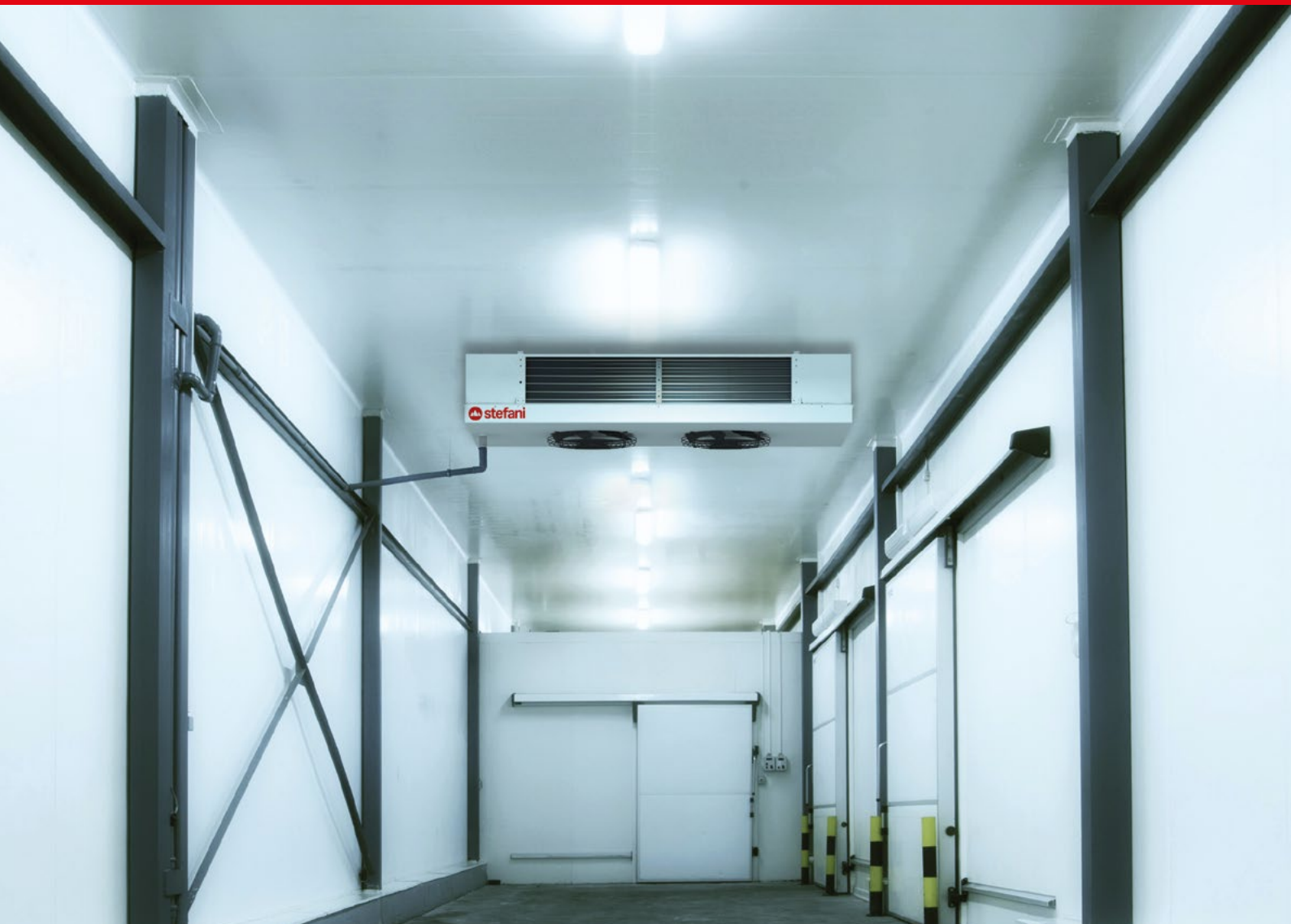

ZEFIRO

Dual discharge air cooler





ZEFIRO is the dual discharge air cooler for refrigeration applications, especially for processing rooms or environments that require a double flow of air.

ZEFIRO

Dual discharge air cooler

FLUIDS AVAILABLE

- Synthetic refrigerants
- Brine
- CO₂

- 10%

**REFRIGERANT CHARGE
COMPARED TO MARKET REFERENCE**

153

models

459

versions

From 1 to 55 kW

DT 8K Capacity

Up to 2 kW/lt

SC2 fin spacing 4,5 mm

+ 8%

increased thickness
high-efficiency rippled tube

+ 20%

increased thickness
high-efficiency louvered fins



Performance



kW/It and kW/W performance
at the top of the market.



Optimized plenum
to optimize the air fluid dynamic
efficiency.



Comfortable working conditions
thanks to low speed fans.

Solidity



Increased thicknesses in the coil
without compromising
on material quality.



**Pre-painted aluminium 15/10
metal casing**
for excellent solidity.



Great accessibility
with internal inner drain tray sized
for efficient drainag.

ZEFIRO

Dual discharge air cooler

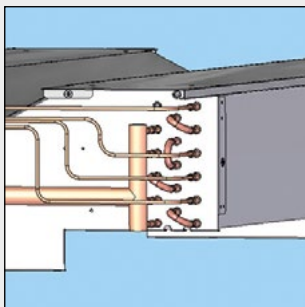

Reliability

With increased thicknesses and aluminum endplates.

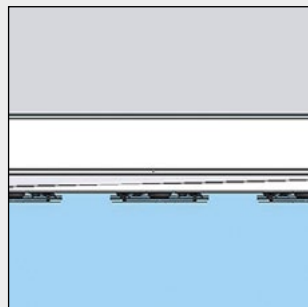

Cooler for processing room

Fitted to the ceiling design.

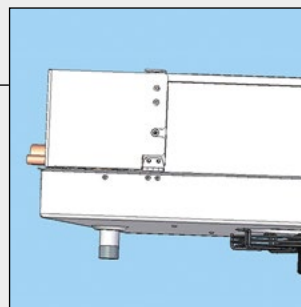

Aluminum casing and drain connections

For high solidity.

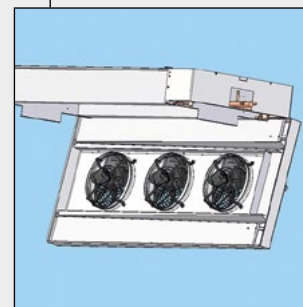

Machine easy to sanitise

Thanks to hinged casing.

Accessories

- EC fan motors
- AISI 304 casing
- Insulated double dip tray
- Cataphoresis coil treatment



Range

Machine height (slim)	280 ÷ 500 mm (depending on fans)
3 fin spacing	3 - 4,5 - 7 mm
Fan size	Ø 250 - 315 - 350 - 450 mm
DT 8K Capacity	1 ÷ 55 kW
Number of fans	1 ÷ 4

	Fan size Ø mm	DT 8K Capacity kW	3 fin spacing mm
ZEFIRO E 25	250	1 ÷ 6	3 - 4,5 - 7
ZEFIRO E 31	315	3 ÷ 14	3 - 4,5 - 7
ZEFIRO E 35	350	4 ÷ 20	3 - 4,5 - 7
ZEFIRO E 45	450	10 ÷ 55	3 - 4,5 - 7

ZEFIRO E 25

Dual discharge air cooler



Ø 250 mm
FANS SIZE

1 ÷ 6 kW
DT 8K CAPACITY

3 - 4,5 - 7 mm
3 FIN SPACING



ZEFIRO E 25-1

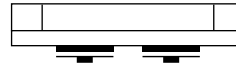

ZEFIRO E 25-2

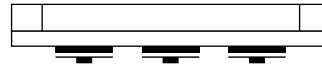

ZEFIRO E 25-3



ZEFIRO E 25-4

DIMENSIONS

ZEFIRO E 25-1

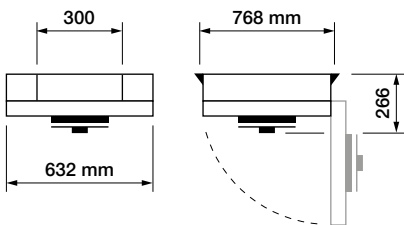

ZEFIRO E 25-2

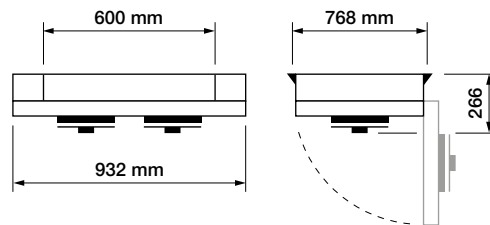

ZEFIRO E 25-3

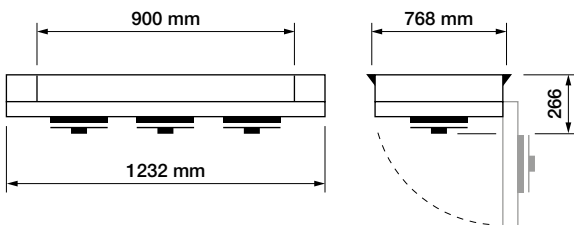

ZEFIRO E 25-4

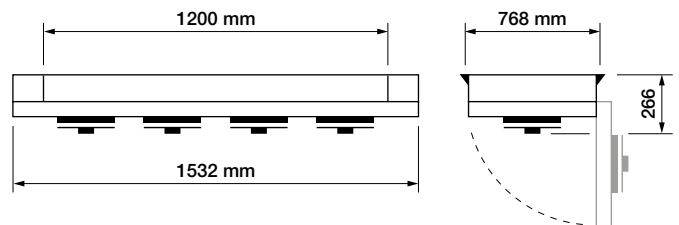

SELECTION CODE

ZEFIRO E 25 1 C 4,5 A 4S

ZEFIRO	dual discharge air cooler
E	E = direct expansion C = CO ₂ dx W = brine P = pumped
25	fan size Ø 250 mm
1	number of fans
C	coil type
4,5	fin spacing mm

A	A = air defrost E = electric defrost W = water defrost
4	electric motor poles
S	S = single phase D = three phase high speed Y = three phase slow speed
EC	electronic motor if present

ZEFIRO E 25

Dual discharge air cooler



FIN SPACING 3 mm / 4 poles	CAPACITY		SURFACE m ²	AIR FLOW m ³ /h	SOUND PRESSURE dB(A) @ 5m	N° FANS x DIAMETER Nr. x Ø mm	FAN SPEED Rpm	POWER W	CURRENT A	AIR THROW m	DEFROSTING POWER kW	VOLUME lt	WEIGHT kg	Ø IN mm	Ø OUT mm
	SC2 - kW	SC3 - kW													
ZEFIRO E 25-1 C 3 A 4S	1,5	-	7,9	650	38	1x250	1300	95	0,68	5	0,7	0,7	31	12	22
ZEFIRO E 25-2 C 3 A 4S	2,9	-	15,8	1300	41	2x250	1300	190	1,36	5,7	1,4	1,4	43	12	22
ZEFIRO E 25-3 C 3 A 4S	4,5	-	23,7	1900	42	3x250	1300	285	2,04	5,7	2,1	2,1	55	16	28
ZEFIRO E 25-4 C 3 A 4S	5,8	-	31,5	2550	44	4x250	1300	380	2,72	6,4	2,8	2,9	68	16	28

FIN SPACING 4,5 mm / 4 poles	CAPACITY		SURFACE m ²	AIR FLOW m ³ /h	SOUND PRESSURE dB(A) @ 5m	N° FANS x DIAMETER Nr. x Ø mm	FAN SPEED Rpm	POWER W	CURRENT A	AIR THROW m	DEFROSTING POWER kW	VOLUME lt	WEIGHT kg	Ø IN mm	Ø OUT mm
	SC2 - kW	SC3 - kW													
ZEFIRO E 25-1 C 4,5 A 4S	1,3	1	5,4	700	38	1x250	1300	95	0,68	6	0,7	0,7	30	12	22
ZEFIRO E 25-2 C 4,5 A 4S	2,5	1,8	10,7	1450	41	2x250	1300	190	1,36	6,7	1,4	1,4	41	12	22
ZEFIRO E 25-3 C 4,5 A 4S	3,9	3	16,1	2150	42	3x250	1300	285	2,04	6,7	2,1	2,1	53	16	28
ZEFIRO E 25-4 C 4,5 A 4S	5,1	3,8	21,4	2850	44	4x250	1300	380	2,72	7,4	2,8	2,9	64	16	28

FIN SPACING 7 mm / 4 poles	CAPACITY		SURFACE m ²	AIR FLOW m ³ /h	SOUND PRESSURE dB(A) @ 5m	N° FANS x DIAMETER Nr. x Ø mm	FAN SPEED Rpm	POWER W	CURRENT A	AIR THROW m	DEFROSTING POWER kW	VOLUME lt	WEIGHT kg	Ø IN mm	Ø OUT mm
	SC2 - kW	SC3 - kW													
ZEFIRO E 25-1 C 7 A 4S	1	0,8	3,6	800	38	1x250	1300	95	0,68	7	0,7	0,7	29	12	22
ZEFIRO E 25-2 C 7 A 4S	2,1	1,6	7,1	1600	41	2x250	1300	190	1,36	7,7	1,4	1,4	40	12	22
ZEFIRO E 25-3 C 7 A 4S	3,1	2,5	10,7	2400	42	3x250	1300	285	2,04	7,7	2,1	2,1	51	16	28
ZEFIRO E 25-4 C 7 A 4S	4,2	3,2	14,2	3150	44	4x250	1300	380	2,72	8,4	2,8	2,9	62	16	28

SC2: Tc=0°C, UR 85%, Tev=-8°C, R404A
 SC3: Tc=-18°C, UR 95%, Tev=-25°C, R404A

ZEFIRO E 31

Dual discharge air cooler



Ø 315 mm
FANS SIZE

3 ÷ 14 kW
DT 8K CAPACITY

3 - 4,5 - 7 mm
3 FIN SPACING



ZEFIRO E 31-1

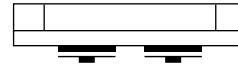

ZEFIRO E 31-2

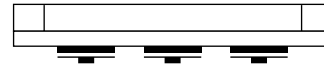

ZEFIRO E 31-3



ZEFIRO E 31-4

DIMENSIONS

ZEFIRO E 31-1

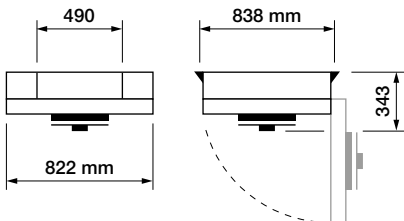

ZEFIRO E 31-2

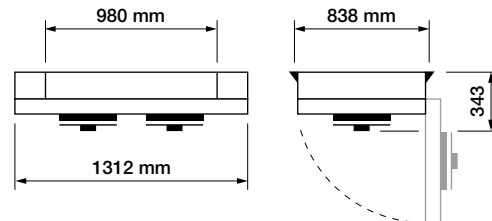

ZEFIRO E 31-3

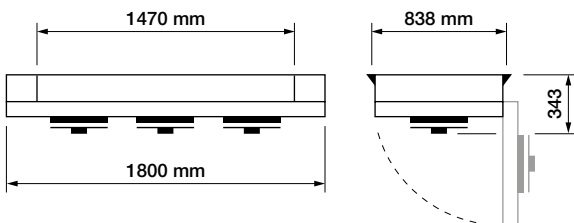

ZEFIRO E 31-4

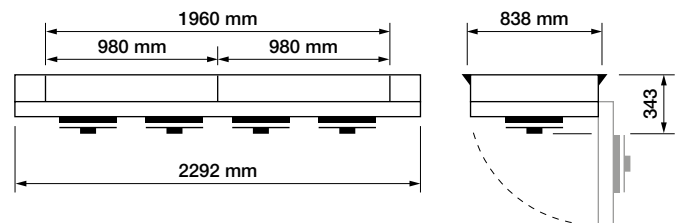

SELECTION CODE

ZEFIRO E 31 1 C 4,5 A 4S

ZEFIRO	dual discharge air cooler
E	E = direct expansion C = CO ₂ dx W = brine P = pumped
31	fan size Ø 315 mm
1	number of fans
C	coil type
4,5	fin spacing mm

A	A = air defrost E = electric defrost W = water defrost
4	electric motor poles
S	S = single phase D = three phase high speed Y = three phase slow speed
EC	electronic motor if present

ZEFIRO E 31

Dual discharge air cooler



FIN SPACING 3 mm / 4 poles	CAPACITY		SURFACE m ²	AIR FLOW m ³ /h	SOUND PRESSURE dB(A) @ 5m	N° FANS x DIAMETER Nr. x Ø mm	FAN SPEED Rpm	POWER W	CURRENT A	AIR THROW m	DEFROSTING POWER kW	VOLUME lt	WEIGHT kg	Ø IN mm	Ø OUT mm
	SC2 - kW	SC3 - kW													
ZEFIRO E 31-1 B 3 A 4S	2,8	-	12,1	1800	37	1x300	1350	110	0,52	12	1,2	1,1	36	12	28
ZEFIRO E 31-1 C 3 A 4S	3,5	-	16,1	1700	37	1x300	1350	110	0,52	10	1,2	1,4	37	12	28
ZEFIRO E 31-2 B 3 A 4S	5,5	-	24,1	3600	39	2x300	1350	220	1,04	13	2,4	2,2	52	12	28
ZEFIRO E 31-2 C 3 A 4S	6,9	-	32,2	3350	39	2x300	1350	220	1,04	11	2,4	2,9	54	12	28
ZEFIRO E 31-3 B 3 A 4S	8,4	-	36,2	5400	41	3x300	1350	330	1,56	13	3,6	3,2	68	12	28
ZEFIRO E 31-3 C 3 A 4S	10,0	-	48,3	5050	41	3x300	1350	330	1,56	11	3,6	4,3	71	16	28
ZEFIRO E 31-4 B 3 A 4S	10,7	-	48,3	7200	42	4x300	1350	440	2,08	14	4,8	4,3	84	16	35
ZEFIRO E 31-4 C 3 A 4S	14,0	-	64,4	6700	42	4x300	1350	440	2,08	12	4,8	5,8	88	16	35

FIN SPACING 4,5 mm / 4 poles	CAPACITY		SURFACE m ²	AIR FLOW m ³ /h	SOUND PRESSURE dB(A) @ 5m	N° FANS x DIAMETER Nr. x Ø mm	FAN SPEED Rpm	POWER W	CURRENT A	AIR THROW m	DEFROSTING POWER kW	VOLUME lt	WEIGHT kg	Ø IN mm	Ø OUT mm
	SC2 - kW	SC3 - kW													
ZEFIRO E 31-1 B 4,5 A 4S	2,3	-	8,2	1900	37	1x300	1350	110	0,52	12	1,0	1,1	36	12	28
ZEFIRO E 31-1 C 4,5 A 4S	2,8	-	10,9	1800	37	1x300	1350	110	0,52	10	1,0	1,4	37	12	28
ZEFIRO E 31-2 B 4,5 A 4S	4,4	-	16,4	3800	39	2x300	1350	220	1,04	13	2,0	2,2	52	12	28
ZEFIRO E 31-2 C 4,5 A 4S	5,7	-	21,9	3550	39	2x300	1350	220	1,04	11	2,0	2,9	54	12	28
ZEFIRO E 31-3 B 4,5 A 4S	6,8	-	24,6	5650	41	3x300	1350	330	1,56	13	3,0	3,2	68	12	28
ZEFIRO E 31-3 C 4,5 A 4S	8,6	-	32,8	5350	41	3x300	1350	330	1,56	11	3,0	4,3	71	16	28
ZEFIRO E 31-4 B 4,5 A 4S	8,9	-	32,8	7550	42	4x300	1350	440	2,08	14	4,0	4,3	84	16	35
ZEFIRO E 31-4 C 4,5 A 4S	11,8	-	43,7	7150	42	4x300	1350	440	2,08	12	4,0	5,8	88	16	35

FIN SPACING 7 mm / 4 poles	CAPACITY		SURFACE m ²	AIR FLOW m ³ /h	SOUND PRESSURE dB(A) @ 5m	N° FANS x DIAMETER Nr. x Ø mm	FAN SPEED Rpm	POWER W	CURRENT A	AIR THROW m	DEFROSTING POWER kW	VOLUME lt	WEIGHT kg	Ø IN mm	Ø OUT mm
	SC2 - kW	SC3 - kW													
ZEFIRO E 31-1 B 7 A 4S	1,8	1,4	5,4	1950	37	1x300	1350	110	0,52	12,0	1,0	1,1	36	12	28
ZEFIRO E 31-1 C 7 A 4S	2,1	1,7	7,3	1900	37	1x300	1350	110	0,52	10,0	1,0	1,4	37	12	28
ZEFIRO E 31-2 B 7 A 4S	3,2	2,6	10,9	3950	39	2x300	1350	220	1,04	13,0	2,0	2,2	52	12	28
ZEFIRO E 31-2 C 7 A 4S	4,5	3,4	14,5	3750	39	2x300	1350	220	1,04	11,0	2,0	2,9	54	12	28
ZEFIRO E 31-3 B 7 A 4S	5,2	4,1	16,3	5900	41	3x300	1350	330	1,56	13,0	3,0	3,2	68	12	28
ZEFIRO E 31-3 C 7 A 4S	6,7	5,2	21,8	5650	41	3x300	1350	330	1,56	11,0	3,0	4,3	71	16	28
ZEFIRO E 31-4 B 7 A 4S	6,9	5,3	21,8	7850	42	4x300	1350	440	2,08	14,0	4,0	4,3	84	16	35
ZEFIRO E 31-4 C 7 A 4S	9,2	7,2	29,0	7500	42	4x300	1350	440	2,08	12,0	4,0	5,8	88	16	35

SC2: T_c=0°C, UR 85%, T_{ev}=-8°C, R404A
 SC3: T_c=-18°C, UR 95%, T_{ev}=-25°C, R404A

ZEFIRO E 35

Dual discharge air cooler



Ø 350 mm

FANS SIZE

4 ÷ 20 kW

DT 8K CAPACITY

3 - 4,5 - 7 mm

3 FIN SPACING



ZEFIRO E 35-1



ZEFIRO E 35-2

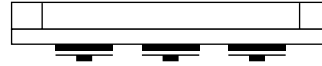

ZEFIRO E 35-3



ZEFIRO E 35-4

DIMENSIONS

ZEFIRO E 35-1

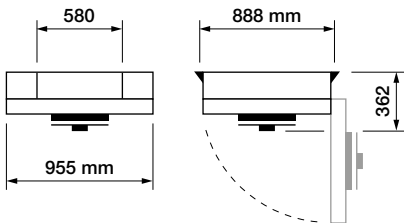

ZEFIRO E 35-2

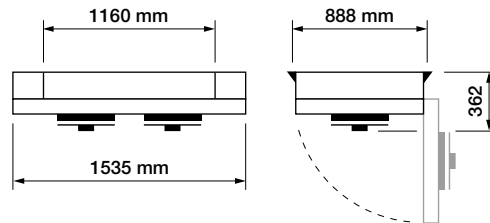

ZEFIRO E 35-3

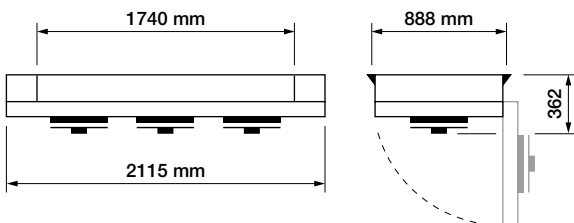

ZEFIRO E 35-4

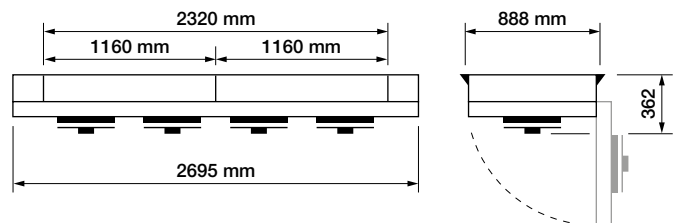

SELECTION CODE

ZEFIRO E 35 1 C 4,5 A 4S

ZEFIRO	dual discharge air cooler
E	E = direct expansion C = CO ₂ dx W = brine P = pumped
35	fan size Ø 350 mm
1	number of fans
C	coil type
4,5	fin spacing mm

A	A = air defrost E = electric defrost W = water defrost
4	electric motor poles
S	S = single phase D = three phase high speed Y = three phase slow speed
EC	electronic motor if present

ZEFIRO E 35

Dual discharge air cooler



FIN SPACING 3 mm / 4 poles	CAPACITY		SURFACE m ²	AIR FLOW m ³ /h	SOUND PRESSURE dB(A) @ 5m	N° FANS x DIAMETER Nr. x Ø mm	FAN SPEED Rpm	POWER W	CURRENT A	AIR THROW m	DEFROSTING POWER kW	VOLUME lt	WEIGHT kg	Ø IN mm	Ø OUT mm
	SC2 - kW	SC3 - kW													
ZEFIRO E 35-1 B 3 A 4S	4,2	-	17,1	2600	44	1x350	1340	165	0,73	14	1,5	1,6	44	12	28
ZEFIRO E 35-1 C 3 A 4S	5,0	-	22,9	2450	44	1x350	1340	165	0,73	12	1,5	2,1	45	12	28
ZEFIRO E 35-2 B 3 A 4S	8,2	-	34,3	5150	46	2x350	1340	330	1,46	15	3,0	3,1	65	16	35
ZEFIRO E 35-2 C 3 A 4S	10,1	-	45,7	4850	46	2x350	1340	330	1,46	13	3,0	4,1	68	16	35
ZEFIRO E 35-3 B 3 A 4S	12,3	-	51,4	7750	48	3x350	1340	495	2,19	15	4,5	4,7	86	16	35
ZEFIRO E 35-3 C 3 A 4S	15,2	-	68,6	7300	48	3x350	1340	495	2,19	13	4,5	6,2	90	16	35
ZEFIRO E 35-4 B 3 A 4S	15,9	-	68,6	10300	49	4x350	1340	660	2,92	16	6,0	6,2	107	16	35
ZEFIRO E 35-4 C 3 A 4S	19,6	-	91,4	9700	49	4x350	1340	660	2,92	14	6,0	8,3	113	22	42

FIN SPACING 4,5 mm / 4 poles	CAPACITY		SURFACE m ²	AIR FLOW m ³ /h	SOUND PRESSURE dB(A) @ 5m	N° FANS x DIAMETER Nr. x Ø mm	FAN SPEED Rpm	POWER W	CURRENT A	AIR THROW m	DEFROSTING POWER kW	VOLUME lt	WEIGHT kg	Ø IN mm	Ø OUT mm
	SC2 - kW	SC3 - kW													
ZEFIRO E 35-1 B 4,5 A 4S	3,3	-	11,7	2700	44	1x350	1340	165	0,73	14	1,2	1,6	44	12	28
ZEFIRO E 35-1 C 4,5 A 4S	4,1	-	15,5	2550	44	1x350	1340	165	0,73	12	1,2	2,1	45	12	28
ZEFIRO E 35-2 B 4,5 A 4S	6,5	-	23,3	5400	46	2x350	1340	330	1,46	15	2,4	3,1	65	16	35
ZEFIRO E 35-2 C 4,5 A 4S	8,2	-	31,1	5150	46	2x350	1340	330	1,46	13	2,4	4,1	68	16	35
ZEFIRO E 35-3 B 4,5 A 4S	10,0	-	35,0	8100	48	3x350	1340	495	2,19	15	3,6	4,7	86	16	35
ZEFIRO E 35-3 C 4,5 A 4S	12,4	-	46,6	7700	48	3x350	1340	495	2,19	13	3,6	6,2	90	16	35
ZEFIRO E 35-4 B 4,5 A 4S	13,0	-	46,6	10800	49	4x350	1340	660	2,92	16	4,8	6,2	107	16	35
ZEFIRO E 35-4 C 4,5 A 4S	16,7	-	62,1	10300	49	4x350	1340	660	2,92	14	4,8	8,3	113	22	42

FIN SPACING 7 mm / 4 poles	CAPACITY		SURFACE m ²	AIR FLOW m ³ /h	SOUND PRESSURE dB(A) @ 5m	N° FANS x DIAMETER Nr. x Ø mm	FAN SPEED Rpm	POWER W	CURRENT A	AIR THROW m	DEFROSTING POWER kW	VOLUME lt	WEIGHT kg	Ø IN mm	Ø OUT mm
	SC2 - kW	SC3 - kW													
ZEFIRO E 35-1 B 7 A 4S	2,5	2,0	7,7	2800	44	1x350	1340	165	0,73	14	1,2	1,6	44	12	28
ZEFIRO E 35-1 C 7 A 4S	3,2	2,5	10,3	2700	44	1x350	1340	165	0,73	12	1,2	2,1	45	12	28
ZEFIRO E 35-2 B 7 A 4S	4,9	3,9	15,5	5600	46	2x350	1340	330	1,46	15	2,4	3,1	65	16	35
ZEFIRO E 35-2 C 7 A 4S	6,5	5,1	20,6	5400	46	2x350	1340	330	1,46	13	2,4	4,1	68	16	35
ZEFIRO E 35-3 B 7 A 4S	7,6	6,0	23,2	8400	48	3x350	1340	495	2,19	15	3,6	4,7	86	16	35
ZEFIRO E 35-3 C 7 A 4S	9,7	7,7	30,9	8050	48	3x350	1340	495	2,19	13	3,6	6,2	90	16	35
ZEFIRO E 35-4 B 7 A 4S	10,2	7,7	30,9	11200	49	4x350	1340	660	2,92	16	4,8	6,2	107	16	35
ZEFIRO E 35-4 C 7 A 4S	13,1	10,0	41,2	10750	49	4x350	1340	660	2,92	14	4,8	8,3	113	22	42

SC2: T_c=0°C, UR 85%, T_{ev}=-8°C, R404A
 SC3: T_c=-18°C, UR 95%, T_{ev}=-25°C, R404A

ZEFIRO E 35

Dual discharge air cooler



FIN SPACING 3 mm / 6 poles	CAPACITY		SURFACE m ²	AIR FLOW m ³ /h	SOUND PRESSURE dB(A) @ 5m	N° FANS x DIAMETER Nr. x Ø mm	FAN SPEED Rpm	POWER W	CURRENT A	AIR THROW m	DEFROSTING POWER kW	VOLUME lt	WEIGHT kg	Ø IN mm	Ø OUT mm
	SC2 - kW	SC3 - kW													
ZEFIRO E 35-1 B 3 A 4S	3,3	-	17,1	1650	37	1x350	930	67	0,32	10,2	1,2	1,6	44	12	28
ZEFIRO E 35-1 C 3 A 4S	3,8	-	22,9	1550	37	1x350	930	67	0,32	8,5	1,2	2,1	45	12	28
ZEFIRO E 35-2 B 3 A 4S	6,6	-	34,3	3300	39	2x350	930	134	0,64	11,05	2,4	3,1	65	16	35
ZEFIRO E 35-2 C 3 A 4S	7,7	-	45,7	3100	39	2x350	930	134	0,64	9,35	2,4	4,1	68	16	35
ZEFIRO E 35-3 B 3 A 4S	10,0	-	51,4	4950	41	3x350	930	201	0,96	11,05	3,6	4,7	86	16	35
ZEFIRO E 35-3 C 3 A 4S	11,6	-	68,6	4650	41	3x350	930	201	0,96	9,35	3,6	6,2	90	16	35
ZEFIRO E 35-4 B 3 A 4S	12,9	-	68,6	6600	42	4x350	930	268	1,28	11,9	4,8	6,2	107	16	35
ZEFIRO E 35-4 C 3 A 4S	15,3	-	91,4	6200	42	4x350	930	268	1,28	10,2	4,8	8,3	113	22	42

FIN SPACING 4,5 mm / 6 poles	CAPACITY		SURFACE m ²	AIR FLOW m ³ /h	SOUND PRESSURE dB(A) @ 5m	N° FANS x DIAMETER Nr. x Ø mm	FAN SPEED Rpm	POWER W	CURRENT A	AIR THROW m	DEFROSTING POWER kW	VOLUME lt	WEIGHT kg	Ø IN mm	Ø OUT mm
	SC2 - kW	SC3 - kW													
ZEFIRO E 35-1 B 4,5 A 4S	2,7	-	11,7	1700	37	1x350	930	67	0,32	11,05	1,2	1,6	44	12	28
ZEFIRO E 35-1 C 4,5 A 4S	3,3	-	15,5	1650	37	1x350	930	67	0,32	9,35	1,2	2,1	45	12	28
ZEFIRO E 35-2 B 4,5 A 4S	5,2	-	23,3	3450	39	2x350	930	134	0,64	11,9	2,4	3,1	65	16	35
ZEFIRO E 35-2 C 4,5 A 4S	6,6	-	31,1	3250	39	2x350	930	134	0,64	10,2	2,4	4,1	68	16	35
ZEFIRO E 35-3 B 4,5 A 4S	8,0	-	35,0	5150	41	3x350	930	201	0,96	11,9	3,6	4,7	86	16	35
ZEFIRO E 35-3 C 4,5 A 4S	9,9	-	46,6	4900	41	3x350	930	201	0,96	10,2	3,6	6,2	90	16	35
ZEFIRO E 35-4 B 4,5 A 4S	10,8	-	46,6	6900	42	4x350	930	268	1,28	12,75	4,8	6,2	107	16	35
ZEFIRO E 35-4 C 4,5 A 4S	13,2	-	62,1	6550	42	4x350	930	268	1,28	11,05	4,8	8,3	113	22	42

FIN SPACING 7 mm / 6 poles	CAPACITY		SURFACE m ²	AIR FLOW m ³ /h	SOUND PRESSURE dB(A) @ 5m	N° FANS x DIAMETER Nr. x Ø mm	FAN SPEED Rpm	POWER W	CURRENT A	AIR THROW m	DEFROSTING POWER kW	VOLUME lt	WEIGHT kg	Ø IN mm	Ø OUT mm
	SC2 - kW	SC3 - kW													
ZEFIRO E 35-1 B 7 A 4S	2,0	1,6	7,7	1800	37	1x350	930	67	0,32	11,9	1,2	1,6	44	12	28
ZEFIRO E 35-1 C 7 A 4S	2,6	2,0	10,3	1700	37	1x350	930	67	0,32	10,2	1,2	2,1	45	12	28
ZEFIRO E 35-2 B 7 A 4S	3,8	3,0	15,5	3600	39	2x350	930	134	0,64	12,8	2,4	3,1	65	16	35
ZEFIRO E 35-2 C 7 A 4S	5,1	4,0	20,6	3450	39	2x350	930	134	0,64	11,1	2,4	4,1	68	16	35
ZEFIRO E 35-3 B 7 A 4S	6,2	4,8	23,2	5350	41	3x350	930	201	0,96	12,8	3,6	4,7	86	16	35
ZEFIRO E 35-3 C 7 A 4S	7,7	6,0	30,9	5150	41	3x350	930	201	0,96	11,1	3,6	6,2	90	16	35
ZEFIRO E 35-4 B 7 A 4S	8,3	6,3	30,9	7150	42	4x350	930	268	1,28	13,6	4,8	6,2	107	16	35
ZEFIRO E 35-4 C 7 A 4S	10,6	8,0	41,2	6850	42	4x350	930	268	1,28	11,9	4,8	8,3	113	22	42

SC2: Tc=0°C, UR 85%, Tev=-8°C, R404A
 SC3: Tc=-18°C, UR 95%, Tev=-25°C, R404A

ZEFIRO E 45

Dual discharge air cooler



Ø 450 mm

FANS SIZE

10 ÷ 55 kW

DT 8K CAPACITY

3 - 4,5 - 7 mm

3 FIN SPACING



ZEFIRO E 45-1

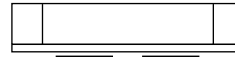

ZEFIRO E 45-2



ZEFIRO E 45-3



ZEFIRO E 45-4

DIMENSIONS

ZEFIRO E 45-1

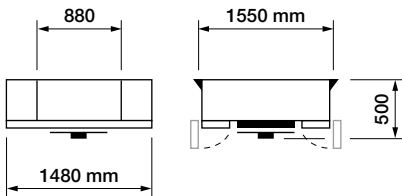

ZEFIRO E 45-2

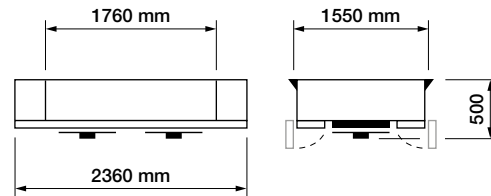

ZEFIRO E 45-3

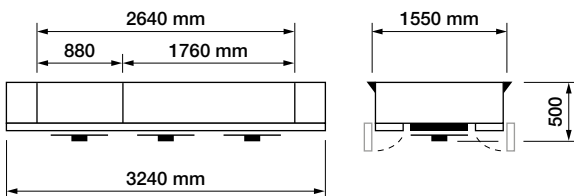

ZEFIRO E 45-4

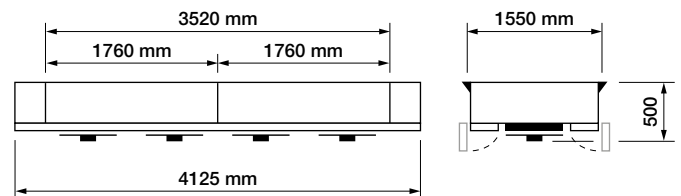

SELECTION CODE

ZEFIRO E 45 1 C 4,5 A 4S

ZEFIRO	dual discharge air cooler
E	E = direct expansion C = CO ₂ dx W = brine P = pumped
45	fan size Ø 450 mm
1	number of fans
C	coil type
4,5	fin spacing mm

A	A = air defrost E = electric defrost W = water defrost
4	electric motor poles
S	S = single phase D = three phase high speed Y = three phase slow speed
EC	electronic motor if present

ZEFIRO E 45

Dual discharge air cooler



FIN SPACING 3 mm / 4 poles	CAPACITY		SURFACE m ²	AIR FLOW m ³ /h	SOUND PRESSURE dB(A) @ 5m	N° FANS x DIAMETER Nr. x Ø mm	FAN SPEED Rpm	POWER W	CURRENT A	AIR THROW m	DEFROSTING POWER kW	VOLUME lt	WEIGHT kg	Ø IN mm	Ø OUT mm
	SC2 - kW	SC3 - kW													
ZEFIRO E 45-1 C 3 A 4S	9,7	-	34,6	5500	47	1x450	1310	490	2,36	19	4,5	5,0	88	12	28
ZEFIRO E 45-1 E 3 A 4S	12,1	-	51,9	5100	47	1x450	1310	490	2,36	17	4,5	7,4	93	16	35
ZEFIRO E 45-1 G 3 A 4S	13,5	-	69,3	4750	47	1x450	1310	490	2,36	16	7,5	9,9	99	22	42
ZEFIRO E 45-2 C 3 A 4S	19,7	-	69,3	11000	50	2x450	1310	980	4,72	20	9,0	9,9	134	22	42
ZEFIRO E 45-2 E 3 A 4S	24,5	-	103,9	10150	50	2x450	1310	980	4,72	18	9,0	14,9	145	22	42
ZEFIRO E 45-2 G 3 A 4S	27,2	-	138,5	9500	50	2x450	1310	980	4,72	17	15,0	19,9	155	28	54
ZEFIRO E 45-3 C 3 A 4S	29,7	-	103,9	16500	52	3x450	1310	1470	7,08	20	13,5	14,9	180	22	42
ZEFIRO E 45-3 E 3 A 4S	36,9	-	155,8	15250	52	3x450	1310	1470	7,08	18	13,5	22,3	196	28	54
ZEFIRO E 45-3 G 3 A 4S	40,9	-	207,8	14200	52	3x450	1310	1470	7,08	17	22,5	29,8	212	28	54
ZEFIRO E 45-4 C 3 A 4S	39,6	-	138,5	22000	53	4x450	1310	1960	9,44	21	18,0	19,9	226	28	54
ZEFIRO E 45-4 E 3 A 4S	49,2	-	207,8	20350	53	4x450	1310	1960	9,44	19	18,0	29,8	248	28	54
ZEFIRO E 45-4 G 3 A 4S	54,6	-	277	18950	53	4x450	1310	1960	9,44	18	30,0	39,7	269	28	54

FIN SPACING 4,5 mm / 4 poles	CAPACITY		SURFACE m ²	AIR FLOW m ³ /h	SOUND PRESSURE dB(A) @ 5m	N° FANS x DIAMETER Nr. x Ø mm	FAN SPEED Rpm	POWER W	CURRENT A	AIR THROW m	DEFROSTING POWER kW	VOLUME lt	WEIGHT kg	Ø IN mm	Ø OUT mm
	SC2 - kW	SC3 - kW													
ZEFIRO E 45-1 C 4,5 A 4S	7,9	-	23,6	5700	47	1x450	1310	490	2,36	19	4,5	5,0	88	12	28
ZEFIRO E 45-1 E 4,5 A 4S	10,5	-	35,5	5350	47	1x450	1310	490	2,36	17	4,5	7,4	93	16	35
ZEFIRO E 45-1 G 4,5 A 4S	12,1	-	47,3	5050	47	1x450	1310	490	2,36	16	7,5	9,9	99	22	42
ZEFIRO E 45-2 C 4,5 A 4S	15,9	-	47,3	11450	50	2x450	1310	980	4,72	20	9,0	9,9	134	22	42
ZEFIRO E 45-2 E 4,5 A 4S	21,1	-	70,9	10750	50	2x450	1310	980	4,72	18	9,0	14,9	145	22	42
ZEFIRO E 45-2 G 4,5 A 4S	24,4	-	94,6	10150	50	2x450	1310	980	4,72	17	15,0	19,9	155	28	54
ZEFIRO E 45-3 C 4,5 A 4S	24,0	-	70,9	17150	52	3x450	1310	1470	7,08	20	13,5	14,9	180	22	42
ZEFIRO E 45-3 E 4,5 A 4S	31,7	-	106,4	16100	52	3x450	1310	1470	7,08	18	13,5	22,3	196	28	54
ZEFIRO E 45-3 G 4,5 A 4S	36,7	-	141,9	15200	52	3x450	1310	1470	7,08	17	22,5	29,8	212	28	54
ZEFIRO E 45-4 C 4,5 A 4S	32,0	-	94,6	22850	53	4x450	1310	1960	9,44	21	18,0	19,9	226	28	54
ZEFIRO E 45-4 E 4,5 A 4S	42,4	-	141,9	21450	53	4x450	1310	1960	9,44	19	18,0	29,8	248	28	54
ZEFIRO E 45-4 G 4,5 A 4S	48,9	-	189,1	20250	53	4x450	1310	1960	9,44	18	30,0	39,7	269	28	54

FIN SPACING 7 mm / 4 poles	CAPACITY		SURFACE m ²	AIR FLOW m ³ /h	SOUND PRESSURE dB(A) @ 5m	N° FANS x DIAMETER Nr. x Ø mm	FAN SPEED Rpm	POWER W	CURRENT A	AIR THROW m	DEFROSTING POWER kW	VOLUME lt	WEIGHT kg	Ø IN mm	Ø OUT mm
	SC2 - kW	SC3 - kW													
ZEFIRO E 45-1 C 7 A 4S	6,2	4,8	15,8	5900	47	1x450	1310	490	2,36	19	4,5	5,0	88	12	28
ZEFIRO E 45-1 E 7 A 4S	8,3	6,5	23,7	5600	47	1x450	1310	490	2,36	17	4,5	7,4	93	16	35
ZEFIRO E 45-1 G 7 A 4S	10,2	7,8	31,6	5350	47	1x450	1310	490	2,36	16	7,5	9,9	99	22	42
ZEFIRO E 45-2 C 7 A 4S	12,4	9,7	31,6	11800	50	2x450	1310	980	4,72	20	9,0	9,9	134	22	42
ZEFIRO E 45-2 E 7 A 4S	16,7	13,1	47,4	11200	50	2x450	1310	980	4,72	18	9,0	14,9	145	22	42
ZEFIRO E 45-2 G 7 A 4S	20,5	15,8	63,2	10700	50	2x450	1310	980	4,72	17	15,0	19,9	155	28	54
ZEFIRO E 45-3 C 7 A 4S	18,7	14,6	47,4	17700	52	3x450	1310	1470	7,08	20	13,5	14,9	180	22	42
ZEFIRO E 45-3 E 7 A 4S	25,1	19,8	71,1	16800	52	3x450	1310	1470	7,08	18	13,5	22,3	196	28	54
ZEFIRO E 45-3 G 7 A 4S	30,8	23,7	94,8	16000	52	3x450	1310	1470	7,08	17	22,5	29,8	212	28	54
ZEFIRO E 45-4 C 7 A 4S	25,0	19,5	63,2	23550	53	4x450	1310	1960	9,44	21	18,0	19,9	226	28	54
ZEFIRO E 45-4 E 7 A 4S	33,6	26,4	94,8	22400	53	4x450	1310	1960	9,44	19	18,0	29,8	248	28	54
ZEFIRO E 45-4 G 7 A 4S	41,1	31,7	126,4	21350	53	4x450	1310	1960	9,44	18	30,0	39,7	269	28	54

SC2: Tc=0°C, UR 85%, Tev=-8°C, R404A
 SC3: Tc=-18°C, UR 95%, Tev=-25°C, R404A

ZEFIRO E 45

Dual discharge air cooler



Lamellenabstände 3 mm / 6 polig	TEHO		PINTA-ALA	ILMANVIR- TAUS	ÄÄNENPAIN	PUH.MÄÄRÄ X HALK.	PUHALLU- SNOPEUS	OTTOTEHO	VIRTA	HEITTOPI- TUUS	SULATUSTEHO	TILAVUUS	PAINO	Ø SISÄÄN	Ø ULOS
	SC2 - kW	SC3 - kW	m²	m³/h	dB(A) @ 5m	No. x Ø mm	Rpm	W	A	m	kW	lt	kg	mm	mm
ZEFIRO E 45-1 C 3 A 4S	7,7	-	34,6	3550	40	1x450	880	155	0,65	14,45	4,5	5,0	88	12	28
ZEFIRO E 45-1 E 3 A 4S	9,2	-	51,9	3250	40	1x450	880	155	0,65	12,75	4,5	7,4	93	16	35
ZEFIRO E 45-1 G 3 A 4S	9,7	-	69,3	3000	40	1x450	880	155	0,65	11,9	7,5	9,9	99	22	42
ZEFIRO E 45-2 C 3 A 4S	15,6	-	69,3	7100	43	2x450	880	310	1,3	15,3	9,0	9,9	134	22	42
ZEFIRO E 45-2 E 3 A 4S	18,4	-	103,9	6500	43	2x450	880	310	1,3	13,6	9,0	14,9	145	22	42
ZEFIRO E 45-2 G 3 A 4S	19,6	-	138,5	6000	43	2x450	880	310	1,3	12,75	15,0	19,9	155	28	54
ZEFIRO E 45-3 C 3 A 4S	23,4	-	103,9	10650	45	3x450	880	465	1,95	15,3	13,5	14,9	180	22	42
ZEFIRO E 45-3 E 3 A 4S	27,7	-	155,8	9750	45	3x450	880	465	1,95	13,6	13,5	22,3	196	28	54
ZEFIRO E 45-3 G 3 A 4S	29,4	-	207,8	9000	45	3x450	880	465	1,95	12,75	22,5	29,8	212	28	54
ZEFIRO E 45-4 C 3 A 4S	31,3	-	138,5	14200	46	4x450	880	620	2,6	16,15	18,0	19,9	226	28	54
ZEFIRO E 45-4 E 3 A 4S	37,0	-	207,8	13000	46	4x450	880	620	2,6	14,45	18,0	29,8	248	28	54
ZEFIRO E 45-4 G 3 A 4S	39,2	-	277,0	12000	46	4x450	880	620	2,6	13,6	30,0	39,7	269	28	54

Lamellenabstände 4,5 mm / 6 polig	TEHO		PINTA-ALA	ILMANVIR- TAUS	ÄÄNENPAIN	PUH.MÄÄRÄ X HALK.	PUHALLU- SNOPEUS	OTTOTEHO	VIRTA	HEITTOPI- TUUS	SULATUSTEHO	TILAVUUS	PAINO	Ø SISÄÄN	Ø ULOS
	SC2 - kW	SC3 - kW	m²	m³/h	dB(A) @ 5m	No. x Ø mm	Rpm	W	A	m	kW	lt	kg	mm	mm
ZEFIRO E 45-1 C 4,5 A 4S	6,5	-	23,6	3700	40	1x450	880	155	0,65	15	4,5	5,0	88	12	28
ZEFIRO E 45-1 E 4,5 A 4S	8,1	-	35,5	3450	40	1x450	880	155	0,65	14	4,5	7,4	93	16	35
ZEFIRO E 45-1 G 4,5 A 4S	9,0	-	47,3	3250	40	1x450	880	155	0,65	13	7,5	9,9	99	22	42
ZEFIRO E 45-2 C 4,5 A 4S	13,0	-	47,3	7400	43	2x450	880	310	1,3	16	9,0	9,9	134	22	42
ZEFIRO E 45-2 E 4,5 A 4S	16,2	-	70,9	6900	43	2x450	880	310	1,3	14	9,0	14,9	145	22	42
ZEFIRO E 45-2 G 4,5 A 4S	18,1	-	94,6	6450	43	2x450	880	310	1,3	14	15,0	19,9	155	28	54
ZEFIRO E 45-3 C 4,5 A 4S	19,5	-	70,9	11150	45	3x450	880	465	1,95	16	13,5	14,9	180	22	42
ZEFIRO E 45-3 E 4,5 A 4S	24,4	-	106,4	10350	45	3x450	880	465	1,95	14	13,5	22,3	196	28	54
ZEFIRO E 45-3 G 4,5 A 4S	27,2	-	141,9	9700	45	3x450	880	465	1,95	14	22,5	29,8	212	28	54
ZEFIRO E 45-4 C 4,5 A 4S	26,1	-	94,6	14850	46	4x450	880	620	2,6	17	18,0	19,9	226	28	54
ZEFIRO E 45-4 E 4,5 A 4S	32,5	-	141,9	13800	46	4x450	880	620	2,6	15	18,0	29,8	248	28	54
ZEFIRO E 45-4 G 4,5 A 4S	36,4	-	189,1	12950	46	4x450	880	620	2,6	14	30,0	39,7	269	28	54

Lamellenabstände 7 mm / 6 polig	TEHO		PINTA-ALA	ILMANVIR- TAUS	ÄÄNENPAIN	PUH.MÄÄRÄ X HALK.	PUHALLU- SNOPEUS	OTTOTEHO	VIRTA	HEITTOPI- TUUS	SULATUSTEHO	TILAVUUS	PAINO	Ø SISÄÄN	Ø ULOS
	SC2 - kW	SC3 - kW	m²	m³/h	dB(A) @ 5m	No. x Ø mm	Rpm	W	A	m	kW	lt	kg	mm	mm
ZEFIRO E 45-1 C 7 A 4S	5,0	3,9	15,8	3850	40	1x450	880	155	0,65	16	4,5	5,0	88	12	28
ZEFIRO E 45-1 E 7 A 4S	6,7	5,0	23,7	3600	40	1x450	880	155	0,65	14	4,5	7,4	93	16	35
ZEFIRO E 45-1 G 7 A 4S	7,8	5,9	31,6	3450	40	1x450	880	155	0,65	14	7,5	9,9	99	22	42
ZEFIRO E 45-2 C 7 A 4S	10,1	7,8	31,6	7700	43	2x450	880	310	1,3	17	9,0	9,9	134	22	42
ZEFIRO E 45-2 E 7 A 4S	13,4	10,2	47,4	7250	43	2x450	880	310	1,3	15	9,0	14,9	145	22	42
ZEFIRO E 45-2 G 7 A 4S	15,6	11,8	63,2	6850	43	2x450	880	310	1,3	14	15,0	19,9	155	28	54
ZEFIRO E 45-3 C 7 A 4S	15,1	11,8	47,4	11550	45	3x450	880	465	1,95	17	13,5	14,9	180	22	42
ZEFIRO E 45-3 E 7 A 4S	20,1	15,3	71,1	10850	45	3x450	880	465	1,95	15	13,5	22,3	196	28	54
ZEFIRO E 45-3 G 7 A 4S	23,4	17,7	94,8	10300	45	3x450	880	465	1,95	14	22,5	29,8	212	28	54
ZEFIRO E 45-4 C 7 A 4S	20,2	15,7	63,2	15400	46	4x450	880	620	2,6	18	18,0	19,9	226	28	54
ZEFIRO E 45-4 E 7 A 4S	26,8	20,4	94,8	14500	46	4x450	880	620	2,6	16	18,0	29,8	248	28	54
ZEFIRO E 45-4 G 7 A 4S	31,1	23,7	126,4	13750	46	4x450	880	620	2,6	15	30,0	39,7	269	28	54

SC2: Tc=0°C, UR 85%, Tev=-8°C, R404A
 SC3: Tc=-18°C, UR 95%, Tev=-25°C, R404A



CONFIGURATIONS

RANGE	MODELS			POLES	FIN SPACING	AVAILABLE ON REQUEST			DEFROST		
	Nr.	Nr.	Ø mm						STANDARD ELECTRIC	HOT GAS	WATER
ZEFIRO 25	18	1 ÷ 4	250	4	3 - 4,5 - 7	SYNETIC	BRINE	CO ₂	○	○	
ZEFIRO 31	24	1 ÷ 4	315	4	3 - 4,5 - 7				○	○	
ZEFIRO 35	24	1 ÷ 4	350	4 - 6	3 - 4,5 - 7				○	○	
ZEFIRO 45	36	1 ÷ 4	450	4 - 6	3 - 4,5 - 7				○	○	○

RANGE	ACCESSORIES							
	AFTER HEATING	PRE PAINTED FINS	COIL CATHODE TREATMENT	AISI 304 CASING	INSULATED DOUBLE DIP TRAY	EASY ACCESS	EC FANS	ELECTRIC WIRING
ZEFIRO 25		○	○	○		●	○	●
ZEFIRO 31	○	○	○	○	○	●	○	●
ZEFIRO 35	○	○	○	○	○	●	○	●
ZEFIRO 45	○	○	○	○	○	●	○	●

● Standard

○ Optional



ZEFIRO E 25
ZEFIRO E 31
ZEFIRO E 35
ZEFIRO E 45



Dual discharge air cooler